

# DL-125C

## Programmable 2-Channel Speech Dialer



## Installation Instructions

### 1. INTRODUCTION

#### 1.1 Purpose and Use

The DL-125C is an automatic programmable speech dialer with two alarm inputs. It is designed for verbal reporting of two separate events, one event per input. Each event can be reported to 4 different remote telephones, or both events can be reported to the same 4 telephones. The telephone numbers of the called parties may be frequently reprogrammed by the user.

A communication session with the first / second group of telephones is initiated by triggering alarm inputs Z-1 / Z-2, or by pressing AL-1 / AL-2 on the front panel, respectively. The alarm logic of each input is programmed separately by the installer.

Pulse or DTMF dialing can be used to establish communication with the called party, in accordance with the local telephone network. The dialer performs certain functions in response to DTMF control commands received from remote telephones.

Whenever a message is acknowledged by the called party, the dialer activates a highly sensitive microphone, to allow the called party to monitor the installation site for sound. The "listening-in" period is limited in time, but the called party can send a specific DTMF command to prolong it.

The DL-125C is packaged in a plastic case, with a built-in keypad for programming and operation (see Figure 1). 12 keys serve for entering data, and 4 are function keys. Programmed data is retained in an EEPROM, unaffected by power failures.

Operating power is obtained from the mains through an external 12 VDC power supply. The use of a 12-Volt rechargeable, sealed battery is recommended to provide operating power backup.

Two models are available:

**DL-125C** - allows the user to stop the communication session by pressing the STOP pushbutton.

**DL-125 CA** - does not allow the user to stop the communication session by pressing the STOP pushbutton. This feature is sometimes required by regulatory authorities.

#### 1.2 Applications

- Upgrading alarm control panels that do not have a dialer. Two different events can be reported to remote telephones.
- Stand-alone 2-input 24-hour alarm system, triggered directly by a smoke/shock detectors or a panic button (loop response time 200 ms).
- Looking after infants or old, sick and disabled people. The DL-125C delivers a distress message and then allows the called party to "listen in".
- Supervising unattended technical devices or processes, with verbal reporting of equipment failures or process anomalies.
- Transmitting numeric reports to numeric pagers or voice messages to voice pagers.

#### 1.3 Message Structure

The overall length of the speech message that can be recorded is limited to 20 seconds. Within this limit, the message can be composed of two pre-recorded segments:

- The identification segment, common to both alarm inputs. This segment usually identifies the user or the protected premises.

**Note:** Recording an identification segment is not obligatory. You can record a longer alarm type segment for each input instead.

- The alarm type segment, associated with a specific alarm input. This segment is used to describe the type of event reported ("fire", "intrusion", "panic", etc.).

A transmission initiated by a specific event (one of the two alarms) is composed of the **identification** segment and one of two **alarm type** segments. The order of transmission of the two segments can be selected. For instance, you can select: "The Smith residence, 25 Scarecrow Drive – Fire Alarm", or you can select: "Fire Alarm – the Smith residence, 25 Scarecrow Drive".



Figure 1. DL-125C, Front Panel

#### 1.4 Communication Routine

**Note:** In this section, location numbers identify "memory cells" that retain programmed parameters (see Para. 4.7).

Once triggered into action, the DL-125C introduces a programmed pre-dialing pause (see Location 14 in Para. 4.7). Then it disconnects the local telephone set and engages the telephone line. The DIAL LED lights and the process continues as follows:

- The dialer starts dialing if uninterrupted tone is detected for 2 seconds (see C below). If 5 seconds elapse with no dial tone - the dialer disengages the line, waits 5 seconds and tries again. If another 5 seconds go by without dial tone, the dialing procedure starts anyway (see B below).
- The dialer checks whether a letter is programmed as a prefix to the first telephone number. Letter prefixes impose an additional delay before dialing (see Para. 4.2). The dialer introduces the required delay (if any) and then starts dialing.
- The dialer dials the programmed number. During dialing, the LED either remains lighted (DTMF dialing) or flashes (pulse dialing), depending on the dialing method selected. After dialing, the dialer pauses for 5 seconds and transmits the message prepared for the called party associated with the input that had been triggered.  
**Note:** Message structure is explained in Section 1.3.
- The dialer now waits 3 seconds for the called party to acknowledge (the acknowledge signal is DTMF "1").
- Upon receiving the acknowledge signal, the dialer removes the presently contacted telephone from its task list for the current event. If the "listen in" function is permitted (see Location 10 in Para. 4.7) it will continue as in Paragraphs F and G below. If not, the dialer will go "on hook" and proceed to dial the next number.

**Note:** Without an acknowledgement, the message will be repeated until the maximum number of message repeats is reached (see Location 20 in Para. 4.7). The DL-125 will call the remaining numbers and will then repeatedly retry the number that didn't acknowledge, until the maximum number of dialing attempts is reached (see Locations 12 and 13).

- After acknowledgement, the dialer enables the "listen in" function for a preprogrammed period.
- At the end of the listen-in period, a short beep sounds. If the called party keys "1" within 10 seconds, a new listen-in period begins. Otherwise, the dialer will go "on hook". The listen-in period may be prolonged as many times as necessary or terminated at any time by keying "9" twice in succession.
- Upon conclusion of the communication session with the first telephone, the procedure in A through G above will be repeated for all remaining telephone numbers in the relevant

group (provided that the "non-backup mode" has been selected in Location 24).

**Note:** Location 24 allows selection of "backup" or "non-backup" mode. In the backup mode, acknowledgement from one telephone is enough to close the event. In the "non-backup" mode, acknowledgement must be obtained from all telephones in the group.

## 2. SPECIFICATIONS

**Input Circuits:** 2 normally open (N.O.) or normally closed (N.C.) inputs\*.

**Alarm Logic:** Alarm upon circuit closure or alarm upon circuit opening\*

**Dialing Method:** Pulse or DTMF\*

**Tel. Line Impedance:** 600Ω, or customized to meet local requirements in country of use.

**Reporting Destinations:** Two groups of telephone numbers, 4 telephones in each group. Reporting to one pager requires the memory space dedicated to two telephone numbers.

**Tel No. Length:** 20 digits maximum.

- I. Once the entire communication cycle is concluded, the dialer disengages the line and reverts to the standby state. If you are using the DL-125C model, the communication routine may be aborted at any time by pressing the STOP button on the keypad. If you are using the DL-125CA model, the only way to stop the dialer is to disconnect the power, because the STOP button is disabled.

## 3. INSTALLATION

### 3.1 Mounting

The DL-125C may be installed as a stand-alone unit or within the housing of a host system such as an alarm control panel. The unit includes three parts: the front frame, the electronic module (complete with keypad) and the base. The base must be separated from the other two parts for installation.

- A. Insert a screwdriver into the slot as shown in Figure 2, and push the flexible catch slightly inward to disengage it. Pulling the bottom of the frame upward will allow you to free the two tabs at the top and remove the frame.

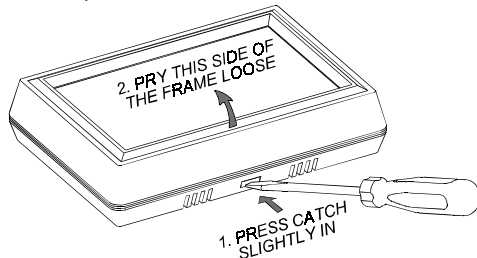

Figure 2. Removing the Front Frame

- B. Insert a screwdriver blade where shown in Figure 3. Dislodge the left side of the module, swing it up and disengage the two right hand legs from their seats. The module may now be detached from the base

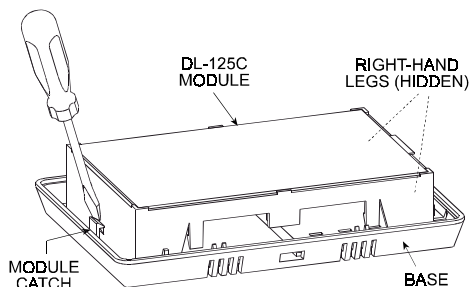

Figure 3. Separating the Module from the Base

- C. Open one of the wiring knockouts (see Fig. 4). Route the wires in and secure the base to the wall or to the host system cabinet, using screws through the three round holes. Complete all wiring as instructed in Para. 3.2.
- D. After wiring, re-attach the DL-125C module to the base.
- E. Remount the front frame: slant it towards the top of the base and engage the two legs at the top. Swing the bottom part of the frame towards the base, and press it against the base until the bottom catch snaps into the slot.

**Speech Message Duration:** 20 seconds max.

**No. of Dialing Attempts:** 1 - 16\*

**No. of Message Repeats:** 1 - 255\*

**Acknowledge Pause between Message Repeats:** 3 seconds

**Power Supply:** 11 -14 VDC

**Current Drain:** 20 mA (standby), 90 mA (max.) @ 12 VDC

**Operating Temperatures:** 0°C to 50°C (32°F to 122°F)

**Size:** 150 x 105 x 35 mm (5-7/8 x 4-1/8 x 1-3/8 in.)

**Weight:** 235g (8.3 oz)

\* Characteristics marked with an asterisk are programmable

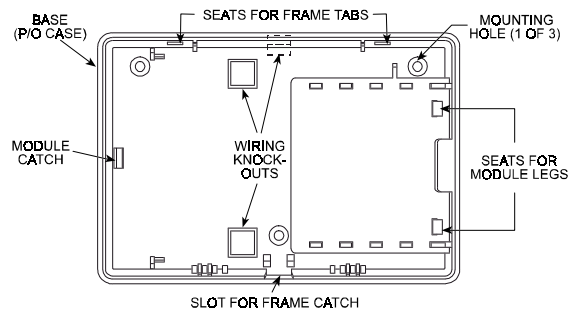

Figure 4. Base Layout

### 3.2 Wiring

Two wiring methods are recommended (see Figures 5 and 6).

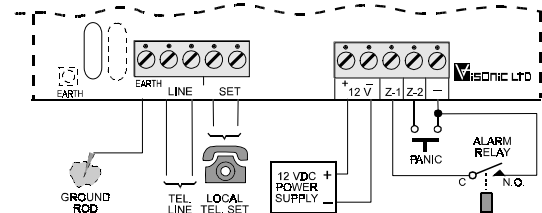

Figure 5. Wiring with Constant Supply of Operating Power

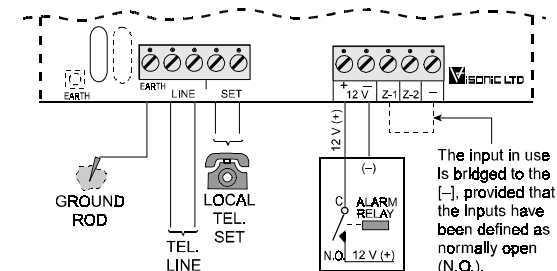

Figure 6. Wiring for Automatic Stopping by Power Cutoff

The Figure 5 wiring configuration assumes that input Z1 is triggered by an alarm relay, and input Z2 by a panic pushbutton. The dialer is constantly powered by 12 VDC.

The Figure 6 wiring configuration assumes that only input Z1 is used. The dialer will be automatically enabled upon alarm, since 12 VDC is supplied via the alarm relay, and Z1 is permanently connected to the [-] terminal. The dialer will be disabled upon stopping the alarm, since the alarm relay cuts off the power. This type of wiring is ideal when the dialer is mounted in a locked box

that prevents access to the STOP pushbutton.

**Note:** Both Z-1 and Z-2 can be programmed as N.O. (normally open) or N.C. (normally closed) inputs (see Locations 22 & 23 in Para. 4.7). With N.O. inputs selected, a short circuit across the relevant input will activate the dialer. With N.C. inputs selected, an open circuit across the relevant input will activate the dialer.

## 4. PROGRAMMING

### 4.1 Programming Fundamentals

The DL-125C employs a non-volatile EEPROM, which stores programmed data and keeps it intact even during power failures. Programming is carried out from the keypad by entering the desired variables or by setting logic flags. Every variable is programmed into a specific location in the memory, and each location is identified by a LOCATION NUMBER. A set of default parameters is programmed at the factory and saved in the EEPROM, but you may change these at will (see Para. 4.7). The programming format consists of the following successive entries:

**[PROG] <LOC> [#] <VAL> [#]**

**[PROG]** and **[#]** are keys provided on the keypad. **[PROG]** starts the programming sequence and **[#]** confirms the preceding entry. **<LOC>** is the location number. A leading zero may be ignored, so Location 06 may be entered as a single digit – **<6>**.

**<VAL>** is the value or code entered into the selected location.

**Refer to the PROGRAMMING CHART (Para. 4.7) for a full list of locations, permissible entries and function details**

**Caution!** If an invalid parameter is entered at any stage, the LED will flash rapidly for 2 seconds and programming will be aborted.

You will sometimes have to key the hexadecimal digits B, C, D and E (see Para. 4.2 and 4.5 below). These digits are marked on certain keys (see Figure 1). To start the hexadecimal mode, press **[\*]**. The DIAL LED near the keyboard will flash rapidly. Next, press the key with the desired letter. The keypad will automatically revert to its normal numerical function, and the LED will stop flashing. Press **[\*]** again if you wish to key another letter. Voice recording instructions are given in Paragraph 4.4.

### 4.2 Entering Telephone Numbers

Telephone numbers are entered in locations 1 through 4 (1st group) and 5 through 8 (2nd group). The programming format is:

**[PROG] <LOC> [#] <NUM.> [#]**

- Enter the programming mode by pressing the PROG key. The DIAL LED should light steadily.
- Select the location for the telephone number you wish to program by keying its location (LOC) number. The DIAL LED should flash once for each keystroke.
- Press **[#]** to confirm the location number. The LED should flash twice.
- Key the telephone number (NUM), digit by digit. The DIAL LED should flash once for each digit. There is a 20-digit limit, including inter-digit pauses (see following note).

**Note:** To program pauses between dialed digits, as sometimes required when PABX systems are used, the following entries are available:

Code Letter	Key Strokes	Resultant Function
B	<b>[*][1]</b>	wait 5 seconds or wait for dial tone, whichever comes first, and continue dialing.
C	<b>[*][2]</b>	wait 10 seconds and continue dialing.
D	<b>[*][3]</b>	wait 5 seconds for dial tone and disengage the line if none is received.

After pressing **[\*]**, the LED indicator flashes until a letter key is pressed.

- Having entered the last digit, finish off by keying **[#]**. The DIAL LED indicator will extinguish.
- To program another telephone number, repeat the procedure outlined in steps A to E above.

Use 14 gauge wire or larger to connect the EARTH terminal to the nearest electrical ground, preferably a ground rod.

### Failure to earth the unit compromises safety!

The phone connected to the **SET** terminals will be automatically disconnected from the line whenever the dialer goes into action.

### 4.3 Deleting Telephone Numbers

A telephone number location will "blank out" if you go through the programming process as in B above but skip the telephone number. The deleting format is therefore:

**[PROG] <LOC> [#] [#]**

**Note:** The number already programmed into any location between 1 and 8 may be verified by using the following format:

**[PROG] <LOC> [\*]**

This initiates a communication session with the particular telephone, and provides a chance to verify correctness of the programmed phone number.

### 4.4 Recording and Erasing

#### A. Recording Order

The verbal messages must be recorded in the order given below: The identification segment first (details of user, or site, or both) 1st alarm segment second (description of 1st alarm type) 2nd alarm segment third (description of 2nd alarm type).

**Note:** Failure to comply with this rule may produce unexpected results. If so, just record again in the correct order.

The time available for all 3 segments is 20 seconds, and the maximum length of the identification segment is 15 seconds.

#### B. Recording Procedure

Message Segment	Actions Required	Response
Identification (variable duration, 15 s max.)	① <b>[*][#]</b> ② within 2 sec.: <b>[AL-1]+[AL-2]</b> ③ Keep <b>[AL-1]+[AL-2]</b> down & talk ④ Release <b>[AL-1]+ [AL-2]</b> ⑤ <b>[*][#]</b> to save the message	LED flashes once LED lights steadily Recording starts Recording ends LED extinguishes*
AL-1 (variable duration, shares remaining time with AL-2)	① <b>[*][#]</b> ② within 2 sec.: <b>[AL-1]</b> ③ Keep <b>[AL-1]</b> down & talk ④ Release <b>[AL-1]</b> ⑤ <b>[*][#]</b> to save the message	LED flashes once LED lights steadily Recording starts Recording ends LED extinguishes*
AL-2	As for AL-1, but press AL-2 instead	As for AL-1

\* If recording is not carried out exactly as instructed or time limits are exceeded, the DIAL LED will start flashing to indicate a recording failure. The newly recorded message as well as the old one will be lost. **Record again exactly as instructed.**

#### C. Erasing Recorded Messages

Press **[#]** - the DIAL LED flashes once. Within 2 seconds, press **[AL-1]+[AL-2]**, or **[AL-1]** or **[AL-2]** depending on which message you wish to erase. Then press **[#]** again without recording anything. The previous message will thereby be erased.

### 4.5 Dealing with Pagers

You may program the DL-125C to dial a pager's phone number and send a numeric or verbal message. Communication with a single pager requires two consecutive locations in the DL-125C memory - one for the pager's phone number and another for the numeric data sent to the pager. Since each DL-125C input has 4 memory locations for phone numbers, each input can report to one pager and 2 regular telephones or just two pagers.

If the pager's phone number is entered into Location No. 1, the numeric message for that pager must be entered into the next location (No. 2). If the pager's phone number is entered into Location No. 2, the numeric message for that pager must be entered into the next location (No. 3).

**Important!** Location No. 4 (the last location in the first group) and No. 8 (the last location in the second group) can't be used for pager phone numbers - in both cases there is no "next location" with memory space for the message.

In the backup mode (see Para. 1.4H), it is advisable to use Locations 1 & 2 or 5 & 6 for pager data and the remaining locations for telephone numbers. The DL-125C will therefore call the pager first and, since the pager doesn't acknowledge, at least one of the telephone numbers will also be called.

Numeric pagers accept both the subscriber ID (PIN number) and a numeric message which is registered and forwarded to the subscriber. Voice pagers accept the subscriber ID (PIN number), record a verbal message and relay it to the subscriber.

**Note:** Some pagers have a special phone number assigned to each specific subscriber. This type of pager does not require a PIN number.

Some pagers require an asterisk (\*) as a separator between the subscriber code and the message. Other pagers require the pound symbol (#). Correct programming is totally dependent on your ability to make the dialer "talk" to the paging company's computer in a language it "understands" (Fig. 7).

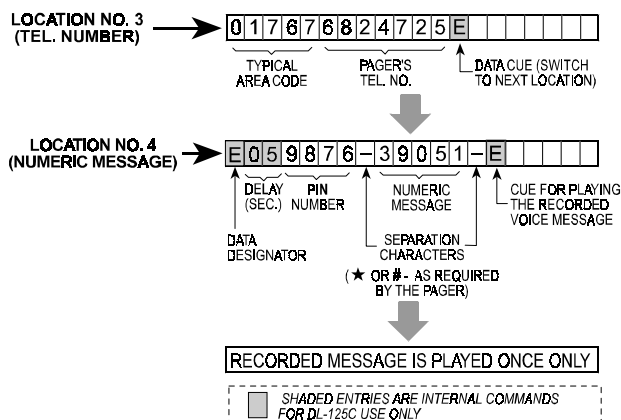

Figure 7. Typical Data Arrangement in Memory

Contact the paging company for specific interface details (PIN or no PIN, separating characters required etc.).

Figure 6 depicts a typical arrangement of data in the DL-125C memory for reporting an event to a pager. In this example, the phone number is entered into memory location No. 3, and the numeric message is entered into the memory location No. 4.

A hexadecimal E at the end of the phone number tells the dialer move to the next memory location and send the data stored in it.

A hexadecimal E at the beginning of a memory location identifies the contents of this location as pager data. A hexadecimal E after the data serves as a cue for playing the voice message.

To program communication with a pager:

- A. Reserve two consecutive memory locations in the same group of four.
- B. Suppose the first location you chose is No. 3. Select it by keying [PROG], <3>, [#].

### 4.7 Programming Chart

Loc No.	Description of Parameters & Code Options	Entry Limits	Programming Format	Factory Default	Prog. Record
1	1st telephone number associated with input Z-1	20 digits	[PR] [1] [#] [Num] [#]**	None	
2	2nd telephone number associated with input Z-1	20 digits	[PR] [2] [#] [Num] [#]**	None	
3	3rd telephone number associated with input Z-1	20 digits	[PR] [3] [#] [Num] [#]**	None	
4	4th telephone number associated with input Z-1	20 digits	[PR] [4] [#] [Num] [#]**	None	
5	1st telephone number associated with input Z-2	20 digits	[PR] [5] [#] [Num] [#]**	None	
6	2nd telephone number associated with input Z-2	20 digits	[PR] [6] [#] [Num] [#]**	None	
7	3rd telephone number associated with input Z-2	20 digits	[PR] [7] [#] [Num] [#]**	None	
8	4th telephone number associated with input Z-2	20 digits	[PR] [8] [#] [Num] [#]**	None	
9	Inaccessible to installers or users	-			
10	Inhibit or permit the listen-in function <b>0 - inhibited; 1 - permitted</b>	0 or 1	[PR] [10] [#] [Code] [#]	1	
11	Select Dialing method: <b>0 - DTMF; 1 - Pulse</b>	0 or 1	[PR] [11] [#] [Code] [#]	0	
12	No. of dialing attempts for alarms at input Z-1	1 - 16*	[PR] [12] [#] [Num] [#]	4	
13	No. of dialing attempts for alarms at input Z-2	1 - 16*	[PR] [13] [#] [Num] [#]	4	
14	Delay (in seconds) between trigger and action (to permit	1 - 255*	[PR] [14] [#] [Sec] [#]	3	

C. Suppose the area code is 01767 and the telephone number is 682-4725. Key in the data as exemplified in Figure 8.

D. Press [#] to confirm the data just entered.

E. Select the next memory location by keying: [PROG], <4>, [#].

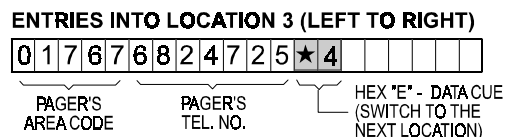

[\*][4] produces a Hexadecimal E, a cue for data in the next memory location.

Figure 8. Programming the Pager's 1st Location

F. Suppose the target pager requires a 5 second interval between the end of dialing and the beginning of the message. Also suppose that the PIN number is 9876 and the message is 39051. Key the data as shown in Fig. 8.

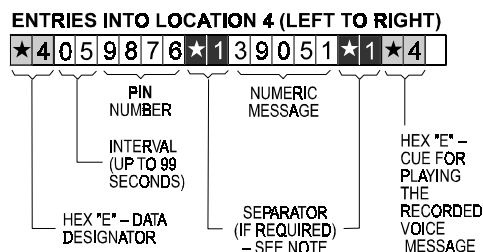

Figure 9. Programming the Pager's 2nd Location

**Notes:** If the required separator is # - key [\*][1]

If the required separator is \* - key [\*][2].

In case of a pager that does not forward voice messages - skip the last [\*][4].

If you need a 5-second delay anywhere within the message, key [\*][3].

G. Press [#] to confirm the data just entered.

### 4.6. Programming Summary

The DL-125C can be programmed equally well in the installer's office or at the installation site. Follow the PROGRAMMING CHART (Para. 4.7) row by row, and enter the appropriate variables. The code options are explained in the second column, and the full programming sequence for each variable is given in the fourth column. Each programming step is enclosed in square brackets, and may include more than one keystroke. The fifth column shows the default values, and the last column (Prog) is left blank for you to fill in your own programmed values.

**Note:** If no key is pressed for 30 seconds, programming will be aborted and the selected location will revert to the previously saved value.

To quit programming at any stage, press the [STOP] key.

	the user to clear a false alarm)				
15	Order of transmission of message segments <b>0 - alarm type segment first:</b> <b>1 - identification segment first</b>	0 or 1	[PR] [15] [#] [Code] [#]	1	
16-19	Inaccessible to installers or users	–			
20	Number of recorded message repeats	1 - 255*	[PR] [20] [#] [Num] [#]	4	
21	Listen-in duration (in seconds)	1 - 255*	[PR] [21] [#] [Sec] [#]	60	
22	Z-1 input definition (Z-1 logic) <b>0 - N.O.; 1 - N.C.</b>	0 or 1	[PR] [22] [#] [Code] [#]	0	
23	Z-2 input definition (Z-2 logic) <b>0 - N.O.; 1 - N.C.</b>	0 or 1	[PR] [23] [#] [Code] [#]	0	
24	Selection of Backup or Non-backup reporting <b>method: 0 - non-backup; 1 - backup (see note)</b>	0 or 1	[PR] [24] [#] [Code] [#]	1	

\* The "00" value is illegal in this memory location

\*\*When programming a 20-digit number, the LED will go off by itself after the 20th digit and the number will be saved.

**Note:** In the Backup reporting mode, receiving an acknowledge signal from a single telephone in a group of 4 is sufficient to consider the current event closed and call off the communication session. The remaining 3 telephones are there for backup purposes only.

In the Non-Backup mode, an acknowledge signal must be received from each telephone in the group of 4 before the current event is considered reported and closed.

## 5. TESTING AND CHECKOUT

After installation, programming, and message recording, correct function should be verified.

Testing can be made easier if you possess a cellular telephone and a portable AM/FM radio. For testing purposes, you can temporarily program your cellular telephone's number in Location 1 (the first telephone in the first group) and in Location 5 (the first telephone in the second group). This way you can monitor both messages and exercise remote control without bothering anyone. Switch the AM/FM radio on to play softly and put it about 2m (6 ft) away from the dialer. Then proceed as follows:

- A. Trigger input Z-1 by opening or closing the circuit, as necessary.
- B. If a predialing pause has not been programmed, the DIAL LED will immediately light. It will remain lighted (tone dialing) or flash (pulse dialing) indicating that the dialer has indeed begun its dialing routine.
- C. If all goes well, your cellular telephone will ring. Answer the call and listen. The message should come through loud and clear. Verify that the message segments are read in the correct order, as programmed (identification segment first or alarm type segment first).
- D. Wait for the 3-second interval between message repetitions and press the "1" key on your telephone. After that, the message should not be repeated any more.

## 6. SPECIAL NOTES

### 6.1 FCC Requirements

1. The Federal Communications Commission (FCC) has established Rules which permit this device to be directly connected to the telephone network. Standardized jacks are used for these connections. This equipment should not be used on party lines or coin lines.
2. If this device is malfunctioning, it may be causing also harm to the telephone network; this device should be disconnected until the source of the problem can be determined, and until repair has been made. If this is not done, the telephone company may temporarily disconnect service.
3. The telephone company may make changes in its technical operations and procedures; if such changes affect the compatibility or use of this device, the telephone company is required to give adequate notice of the changes.
4. If the telephone company requests information on what equipment is connected to their lines, inform them of:
  - (a) The telephone number that this unit is connected to,
  - (b) The ringer equivalence number (0.0B)
  - (c) The USOC jack required (RJ-31X), and
  - (d) The FCC registration number

Items (b) and (d) are indicated on the label. The ringer equivalence number (REN) is used to determine how many devices can be connected to your telephone line. In most areas, the sum of the

- E. If the listening-in function is permitted, you should now start hearing the radio through the telephone's earpiece.

**Note:** To prevent acoustic feedback, move into another room and continue monitoring from there.

- F. Watch for the warning beep that sounds shortly before end of session. Press the "1" key on your telephone and verify that the listen-in period carries on instead of coming to an abrupt end.
- G. Press the telephone's "9" key twice in succession. The dialer should terminate the communication session and go "on hook". If the dialer is in the non-backup mode ("0" has been selected Location 24), press the **STOP** button (DL-125C) or disconnect the power (DL-125CA) to prevent further dialing.
- H. Reconnect the power (DL-125CA only) and trigger input Z-2 by opening or closing the circuit, as necessary.
- I. Repeat steps B through G above for this input too. If all goes well, reprogram the telephone numbers in Locations 1 and 5 as requested by the user.

**Note:** Testing can be carried out without a cellular telephone, provided that you secure cooperation of the called parties. You must warn them in advance that you are about to test the system, explain briefly what they have to do and have them report to you later whether all went well.

RENs of all devices on any one line should not exceed five (5.0). If too many devices are attached, they may not ring properly.

### 6.2 Service Requirements

In the event of equipment malfunction, all repairs should be performed by our Company or an authorized agent. It is the responsibility of users requiring service to report the need for service to our Company or to one of our authorized distributors. Service can be obtained at: Visonic Inc. 10 Northwood Drive, Bloomfield CT. 06002-1911, U.S.A. Phone: (860) 243-0833, (800) 223-0020 Fax: (860) 242-8094

### 6.3 Certification in Canada

The Industry Canada label identifies certified equipment. This certification means that the equipment meets certain telecommunications network protective, operational and safety requirements. The Industry Canada does not guarantee the equipment will operate to the user's satisfaction.

Before installing this equipment, users should ensure that it is permissible to be connected to the facilities of the local telecommunications company. The equipment must also be installed using an acceptable method of connection. In some cases, the company's inside wiring associated with a single line individual service may be extended by means of a certified connector assembly (telephone extension cord). The customer should be aware that compliance with the above conditions may not prevent degradation of service in some situations.

Repairs to certified equipment should be made by an authorized Canadian maintenance facility designated by the supplier. Any repairs or alterations made by the user to this equipment, or equipment malfunctions, may give the telecommunications company cause to request the user to disconnect the equipment.

Users should ensure for their own protection that the electrical ground connections of the power utility, telephone lines and internal metallic water pipe system, if present, are connected together. This precaution may be particularly important in rural areas.

**Caution:** Users should not attempt to make such connections themselves, but should contact the appropriate electric inspection authority, or electrician, as appropriate.

The Load Number (LN) assigned to each terminal device denotes the percentage of the total load to be connected to a telephone loop which is used by the device, to prevent overloading. The termination on a loop may consist of any combination of devices subject only to the requirement that the total of the Load Numbers of all the devices does not exceed 100.

## APPENDIX A. USER INFORMATION

### A.1 User Guidance

We recommend to photo-copy this section for all DL-125C users - the proprietor of the protected premises and all called parties.

*If programmed correctly, the DL-125C will operate automatically without user's intervention. However, the user can initiate an alarm or stop operation manually.*



Pressing AL-1 will cause the dialer to call the 1st group of phone numbers and send them the relevant verbal message.



Pressing AL-2 will cause the dialer to call the 2nd group of phone numbers and send them the relevant verbal message.



Pressing STOP will cause the dialer to stop communicating, disengage the line and check both inputs. If an input is "in alarm", a new communication session will start. If both inputs are "normal", the dialer will stand by.  
**Note:** This function is disabled in the DL-125CA.



Serves as an acknowledgement. The DL-125C will stop sending the message and will permit "listening in". Before the listen-in period ends, the dialer beeps once. Pressing [1] again will start another listen-in period.



Serves as an acknowledgement and causes the dialer to stop sending the message and go "on hook". The dialer will then call the remaining numbers (if programmed to do so).

### A.2 Data Record

#### AL-1 DATA

Message: \_\_\_\_\_

1st called party \_\_\_\_\_

2nd called party \_\_\_\_\_

3rd called party \_\_\_\_\_

4th called party \_\_\_\_\_

#### AL-2 DATA

Message: \_\_\_\_\_

1st called party \_\_\_\_\_

2nd called party \_\_\_\_\_

3rd called party \_\_\_\_\_

4th called party \_\_\_\_\_

### WARRANTY

Visonic Ltd. and/or its subsidiaries and its affiliates ("the Manufacturer") warrants its products hereinafter referred to as "the Product" or "Products" to be in conformance with its own plans and specifications and to be free of defects in materials and workmanship under normal use and service for a period of twelve months from the date of shipment by the Manufacturer. The Manufacturer's obligations shall be limited within the warranty period, at its option, to repair or replace the product or any part thereof. The Manufacturer shall not be responsible for dismantling and/or reinstallation charges. To exercise the warranty the product must be returned to the Manufacturer freight prepaid and insured.

**This warranty does not apply in the following cases:** improper installation, misuse, failure to follow installation and operating instructions, alteration, abuse, accident or tampering, and repair by anyone other than the Manufacturer.

This warranty is exclusive and expressly in lieu of all other warranties, obligations or liabilities, whether written, oral, express or implied, including any warranty of merchantability or fitness for a particular purpose, or otherwise. In no case shall the Manufacturer be liable to anyone for any consequential or incidental damages for breach of this warranty or any other warranties whatsoever, as aforesaid.

This warranty shall not be modified, varied or extended, and the Manufacturer does not authorize any person to act on its behalf in the modification, variation or extension of this warranty. This warranty shall apply to the Product only. All products, accessories or attachments of others used in conjunction with the Product, including batteries, shall be covered solely by their own warranty, if any. The Manufacturer shall not be liable for any damage or loss whatsoever, whether directly, indirectly, incidentally, consequentially or otherwise, caused by the malfunction of the Product due to products, accessories, or attachments of others, including batteries, used in conjunction with the Products.

The Manufacturer does not represent that its Product may not be compromised and/or circumvented, or that the Product will prevent any death, personal and/or bodily injury and/or damage to property resulting from burglary, robbery, fire or otherwise, or that the Product will in all cases provide adequate warning or protection. User understands that a properly installed and maintained alarm may only reduce the risk of events such as burglary, robbery, and fire without warning, but it is not insurance or a guarantee that such will not occur or that there will be no death, personal damage and/or damage to property as a result.

**The Manufacturer shall have no liability for any death, personal and/or bodily injury and/or damage to property or other loss whether direct, indirect, incidental, consequential or otherwise, based on a claim that the Product failed to function.** However, if the Manufacturer is held liable, whether directly or indirectly, for any loss or damage arising under this limited warranty or otherwise, regardless of cause or origin, the Manufacturer's maximum liability shall not in any case exceed the purchase price of the Product, which shall be fixed as liquidated damages and not as a penalty, and shall be the complete and exclusive remedy against the Manufacturer.

**Warning:** The user should follow the installation and operation instructions and among other things test the Product and the whole system at least once a week. For various reasons, including, but not limited to, changes in environmental conditions, electric or electronic disruptions and tampering, the Product may not perform as expected. The user is advised to take all necessary precautions for his /her safety and the protection of his/her property.

6/91



VISONIC LTD. (ISRAEL): P.O.B 22020 TEL-AVIV 61220 ISRAEL. PHONE: (972-3) 645-6789, FAX: (972-3) 645-6788  
 VISONIC INC. (U.S.A.): 10 NORTHWOOD DRIVE, BLOOMFIELD CT. 06002-1911. PHONE: (860) 243-0833, (800) 223-0020 FAX: (860) 242-8094  
 VISONIC LTD. (UK): UNIT 1, STRATTON PARK, DUNTON LANE, BIGGLESWADE, BEDS. SG18 8QS. PHONE: (01767) 600857 FAX: (01767) 601098  
 ©VISONIC LTD. 1998 DL-125C D-5803-0 NEW : DE5803-(REV. 3, 4/98)



MADE IN ISRAEL